



ALUMINIUM
PARSEH

Modern Harmony of Safety
and Aesthetics

پروفیل های لولایی سری ۴۷

Hinged system 47 series

63

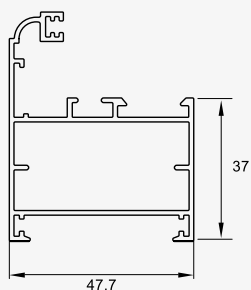
**ALP - 217**

فریم . Frame
0.830 kg/m

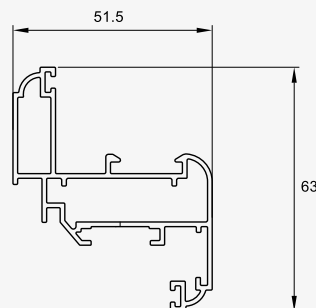
**ALP - 216**

لنگه . Vent
0.880 kg/m

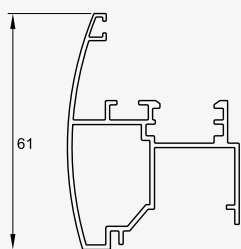
**ALP - 210**

پروفیل میانی دولنگه . Inverter
0.700 kg/m

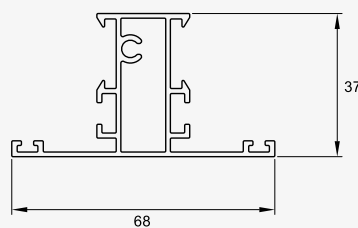
**ALP - 218**

سپری . Transom
0.760 kg/m

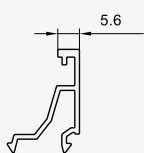
**ALP - 213**

زهواردو جداره . Glazing Bead
0.210 kg/m

**ALP - 214**

زهوارتک جداره . Glazing Bead
0.270 kg/m

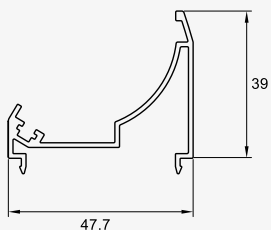
**ALP - 226**

پروفیل گردان فریم ۴۷ . Angel Adapter
0.467 kg/m

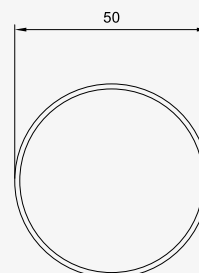
**ALP - 227**

لوله محوری ۵۰ . Pipe Instead Angel
0.540 kg/m

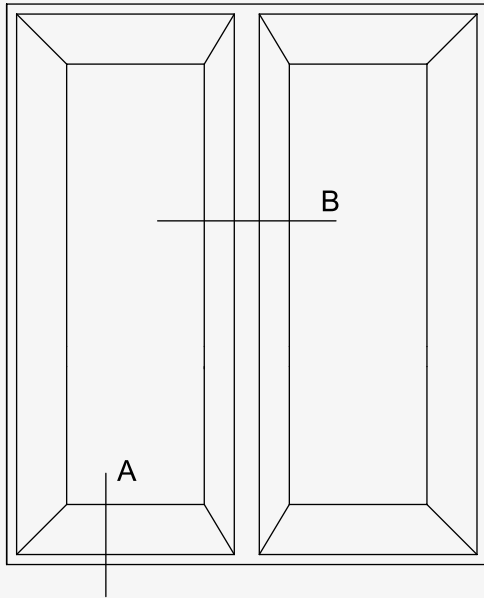

نقشه مونتاژی
Assembling Drawing

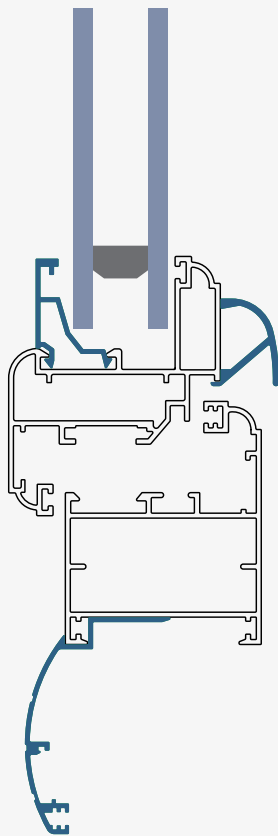

Section A

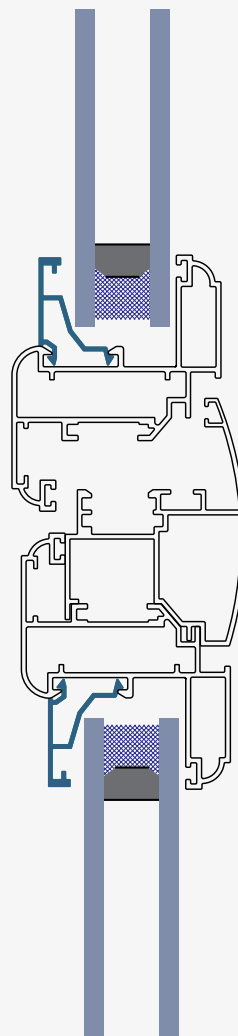

Section B

ALUMINIUM PARSEH

Modern Harmony of Safety
and Aesthetics

